

NATURAL SCIENCES  
ADMISSIONS ASSESSMENT

D568/32

November 2020

60 minutes

## SECTION 2

## INSTRUCTIONS TO CANDIDATES

Please read these instructions carefully, but do not open this question paper until you are told that you may do so. This paper is Section 2 of 2.

A separate answer sheet is provided for this paper. Please check you have one. You also require a soft pencil and an eraser.

Please complete the answer sheet with your candidate number, centre number, date of birth, and name.

This paper contains **three** parts: **X**, **Y** and **Z**.

All candidates should complete only **one** part chosen from:

<b>Part X</b>	Physics
<b>Part Y</b>	Chemistry
<b>Part Z</b>	Biology

Each part has 20 multiple-choice questions. There are no penalties for incorrect responses, only marks for correct answers, so you should attempt **all** 20 questions in your chosen part. Each question is worth one mark.

For each question, choose the **one** option you consider correct and record your choice on the separate answer sheet. If you make a mistake, erase thoroughly and try again.

You **must** complete the answer sheet within the time limit.

You can use the question paper for rough working, but **no extra paper** is allowed. Only your responses on the answer sheet will be marked.

A Periodic Table is included.

Dictionaries and calculators are NOT permitted.

**Please wait to be told you may begin before turning this page.**

*This question paper consists of 67 printed pages and 5 blank pages.*



**BLANK PAGE**

**Paper content**

Periodic Table .....	5
PART X Physics.....	7
PART Y Chemistry .....	29
PART Z Biology.....	51

**BLANK PAGE**

<b>H</b> 1																	<b>He</b> 2
<b>Li</b> 3	<b>Be</b> 4															<b>F</b> 9	<b>Ne</b> 10
<b>Na</b> 11	<b>Mg</b> 12															<b>Cl</b> 17	<b>Ar</b> 18
<b>K</b> 19	<b>Ca</b> 20	<b>Sc</b> 21	<b>Ti</b> 22	<b>V</b> 23	<b>Cr</b> 24	<b>Mn</b> 25	<b>Fe</b> 26	<b>Co</b> 27	<b>Ni</b> 28	<b>Cu</b> 29	<b>Zn</b> 30	<b>Ga</b> 31	<b>Ge</b> 32	<b>As</b> 33	<b>Se</b> 34	<b>Br</b> 35	<b>Kr</b> 36
<b>Rb</b> 37	<b>Sr</b> 38	<b>Y</b> 39	<b>Zr</b> 40	<b>Nb</b> 41	<b>Mo</b> 42	<b>Tc</b> 43	<b>Ru</b> 44	<b>Rh</b> 45	<b>Pd</b> 46	<b>Ag</b> 47	<b>Cd</b> 48	<b>In</b> 49	<b>Sn</b> 50	<b>Sb</b> 51	<b>Te</b> 52	<b>I</b> 53	<b>Xe</b> 54
<b>Cs</b> 55	<b>Ba</b> 56	<i>Lanthanoids</i> 57-71		<b>Ta</b> 73	<b>W</b> 74	<b>Re</b> 75	<b>Os</b> 76	<b>Ir</b> 77	<b>Pt</b> 78	<b>Au</b> 79	<b>Hg</b> 80	<b>Tl</b> 81	<b>Pb</b> 82	<b>Bi</b> 83	<b>Po</b> 84	<b>At</b> 85	<b>Rn</b> 86
<b>Fr</b> 87	<b>Ra</b> 88	<i>Actinoids</i> 89-103		<b>Db</b> 105	<b>Sg</b> 106	<b>Bh</b> 107	<b>Hs</b> 108	<b>Mt</b> 109	<b>Ds</b> 110	<b>Rg</b> 111	<b>Cn</b> 112	<b>Nh</b> 113	<b>Fl</b> 114	<b>Mc</b> 115	<b>Lv</b> 116	<b>Ts</b> 117	<b>Og</b> 118

symbol  
atomic number

<b>Lanthanoids</b>	<b>La</b> 57	<b>Ce</b> 58	<b>Pr</b> 59	<b>Nd</b> 60	<b>Pm</b> 61	<b>Sm</b> 62	<b>Eu</b> 63	<b>Gd</b> 64	<b>Tb</b> 65	<b>Dy</b> 66	<b>Ho</b> 67	<b>Er</b> 68	<b>Tm</b> 69	<b>Yb</b> 70	<b>Lu</b> 71
<b>Actinoids</b>	<b>Ac</b> 89	<b>Th</b> 90	<b>Pa</b> 91	<b>U</b> 92	<b>Np</b> 93	<b>Pu</b> 94	<b>Am</b> 95	<b>Cm</b> 96	<b>Bk</b> 97	<b>Cf</b> 98	<b>Es</b> 99	<b>Fm</b> 100	<b>Md</b> 101	<b>No</b> 102	<b>Lr</b> 103

**BLANK PAGE**

## **PART X Physics**

- 1 Spring P has spring constant  $1.0\text{Ncm}^{-1}$  and spring Q has spring constant  $3.0\text{Ncm}^{-1}$ .

The two springs are connected in series.

The springs are stretched by 6.0cm in total.

What is the extension of spring P?

(The springs have negligible mass and obey Hooke's law.)

- A 1.5 cm
- B 2.0 cm
- C 3.0 cm
- D 4.0 cm
- E 4.5 cm



- 2 A single strand of wire has a radius of  $2.0 \times 10^{-4}$  m and length 15 m. The resistivity of the material from which the wire is made is  $4.8 \times 10^{-7} \Omega \text{ m}$ .

Twelve strands of this wire are connected in parallel to make a cable.

What is the resistance of the cable?

- A  $\frac{\pi}{2160} \Omega$
- B  $\frac{\pi}{180} \Omega$
- C  $\frac{\pi}{15} \Omega$
- D  $\frac{15}{\pi} \Omega$
- E  $\frac{180}{\pi} \Omega$
- F  $\frac{2160}{\pi} \Omega$

- 3 A ray of light is directed into a semicircular transparent block, entering at P. The direction of the ray is adjusted until it strikes the centre of the flat face XY of the block at the critical angle and reflects to Q as shown.

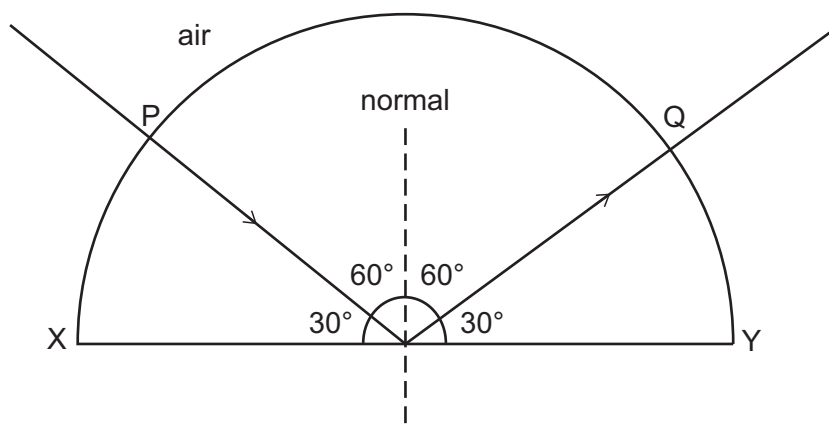

The length of XY is  $L$ .

The speed of light in air is  $c$ .

What is the time taken by the light to travel from P to Q in the block?

- A  $\frac{L\sqrt{3}}{2c}$
- B  $\frac{L}{c}$
- C  $\frac{2L}{c\sqrt{3}}$
- D  $\frac{L\sqrt{3}}{c}$
- E  $\frac{2L}{c}$
- F  $\frac{4L}{c\sqrt{3}}$

- 4 A solid cube with sides of length 20 cm is made from material with density  $2000 \text{ kg m}^{-3}$ . The cube is suspended, in equilibrium, from an initially unstretched spring, and this results in the spring gaining strain energy of 3.2 J.

What is the spring constant of the spring?

(gravitational field strength =  $10 \text{ N kg}^{-1}$ ; the spring obeys Hooke's law)

- A  $40 \text{ N m}^{-1}$
- B  $80 \text{ N m}^{-1}$
- C  $400 \text{ N m}^{-1}$
- D  $800 \text{ N m}^{-1}$
- E  $4000 \text{ N m}^{-1}$
- F  $8000 \text{ N m}^{-1}$

- 5 A projectile is fired upwards from the ground at an angle of  $60^\circ$  to the vertical at a speed of  $20 \text{ m s}^{-1}$ .

It travels a horizontal distance  $d$  and lands with a downwards vertical component of velocity of  $4.0 \text{ m s}^{-1}$  on ground that is height  $h$  above the starting point of the projectile.

What are  $d$  and  $h$ ?

(gravitational field strength =  $10 \text{ N kg}^{-1}$ ; assume that air resistance is negligible)

	$d / \text{m}$	$h / \text{m}$
<b>A</b>	$6.0\sqrt{3}$	4.2
<b>B</b>	$6.0\sqrt{3}$	5.8
<b>C</b>	$10\sqrt{3} - 4.0$	4.2
<b>D</b>	$10\sqrt{3} - 4.0$	14.2
<b>E</b>	$10\sqrt{3} + 4.0$	5.8
<b>F</b>	$10\sqrt{3} + 4.0$	14.2
<b>G</b>	$14\sqrt{3}$	4.2
<b>H</b>	$14\sqrt{3}$	5.8

- 6 Diagram 1 shows the positions of nine equally spaced particles in a medium.

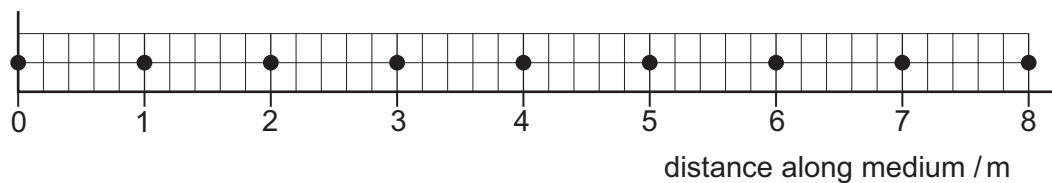

Diagram 1

Diagram 2 shows the positions of the same nine particles, at a particular time, while a longitudinal wave is travelling through the medium.

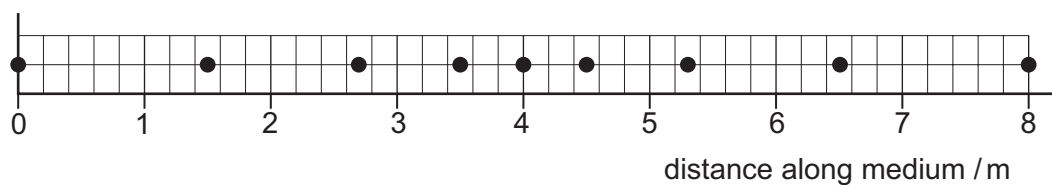

Diagram 2

What is the amplitude of the wave?

- A 0.4 m
- B 0.5 m
- C 0.6 m
- D 0.7 m
- E 2.0 m
- F 4.0 m
- G 6.0 m
- H 8.0 m

- 7 A spaceship with mass  $8.0 \times 10^4 \text{ kg}$  travels at constant velocity and has  $1.0 \times 10^{12} \text{ J}$  of kinetic energy.

An external impulse of  $8.0 \times 10^7 \text{ kg m s}^{-1}$ , lasting for 2.0 s, is applied to the spaceship acting in the opposite direction to the motion of the spaceship.

What is the average rate of loss of kinetic energy of the spaceship during the application of the impulse?

- A  $9.5 \times 10^{10} \text{ W}$
- B  $1.8 \times 10^{11} \text{ W}$
- C  $2.2 \times 10^{11} \text{ W}$
- D  $3.2 \times 10^{11} \text{ W}$
- E  $3.6 \times 10^{11} \text{ W}$
- F  $7.2 \times 10^{11} \text{ W}$

- 8 The diagram shows a solid triangular prism.

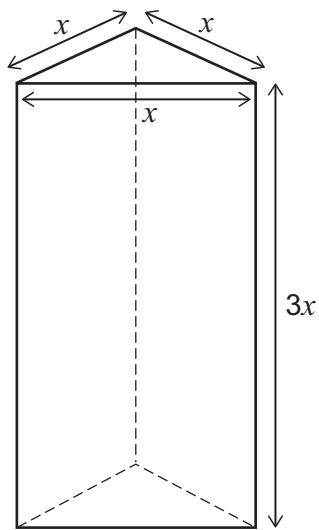

The sides of the triangular cross section of the prism are of length  $x$ .

The height of the prism is  $3x$ .

The uniform density of the prism is  $\rho$ .

The gravitational field strength is  $g$ .

What is the minimum pressure the prism can exert when it rests on level ground?

- A  $3\rho g$
- B  $3\rho gx$
- C  $\frac{\rho g}{4}$
- D  $\frac{\rho gx}{4}$
- E  $\frac{\sqrt{3}\rho g}{4}$
- F  $\frac{\sqrt{3}\rho gx}{4}$

- 9 An apple of mass  $m_a$  is placed on a uniform metre rule with the centre of gravity of the apple at the 10 cm mark. The rule is balanced on a pivot placed at the 35 cm mark.

The apple is replaced with an orange of mass  $m_o$ . The rule now balances with the pivot at the 40 cm mark.

What is the ratio  $\frac{m_a}{m_o}$  ?

A  $\frac{5}{9}$

B  $\frac{4}{5}$

C  $\frac{5}{6}$

D  $\frac{6}{5}$

E  $\frac{5}{4}$

F  $\frac{9}{5}$



- 10** A cyclist travels at a constant speed of  $12 \text{ m s}^{-1}$  on level ground. During this time the power needed to maintain a constant speed is  $900 \text{ W}$ . The total weight of the cyclist and bicycle is  $850 \text{ N}$ .

The cyclist now cycles up a slope at the same constant speed. The slope is at an angle of  $30^\circ$  to the horizontal.

What is the driving force on the bicycle as it travels up the slope?

(Assume that the magnitude of the resistive forces is constant.)

- A**  $75 \text{ N}$
- B**  $350 \text{ N}$
- C**  $500 \text{ N}$
- D**  $(425\sqrt{3} - 75) \text{ N}$
- E**  $775 \text{ N}$
- F**  $(425\sqrt{3} + 75) \text{ N}$
- G**  $925 \text{ N}$

**11** Three identical resistors can be combined in four different arrangements.

One of the arrangements has a resistance of  $18\ \Omega$ .

A different arrangement has a resistance of  $8.0\ \Omega$ .

What are the resistances of the other two arrangements?

(All three resistors contribute to the total resistance in all arrangements.)

**A**  $2.0\ \Omega$  and  $4.0\ \Omega$

**B**  $2.0\ \Omega$  and  $9.0\ \Omega$

**C**  $4.0\ \Omega$  and  $12\ \Omega$

**D**  $4.0\ \Omega$  and  $36\ \Omega$

**E**  $36\ \Omega$  and  $162\ \Omega$

**F**  $81\ \Omega$  and  $162\ \Omega$

- 12** A  $4.0\text{ k}\Omega$  fixed resistor is connected in series with a light dependent resistor (LDR) across a  $100\text{ V}$  dc power supply.

The current in the LDR is  $5.0\text{ mA}$ .

The intensity of light falling on the LDR now decreases and the voltage across the fixed resistor changes by  $50\%$ .

What is the change in the resistance of the LDR as a result of the change in intensity?

- A**  $8.0\text{ k}\Omega$
- B**  $12\text{ k}\Omega$
- C**  $16\text{ k}\Omega$
- D**  $20\text{ k}\Omega$
- E**  $32\text{ k}\Omega$
- F**  $36\text{ k}\Omega$

- 13 An elastic cord with spring constant  $k$  is fixed to two points P and Q on the diameter of a ring so that the cord is taut but unstretched. The radius of the ring is  $r$ .

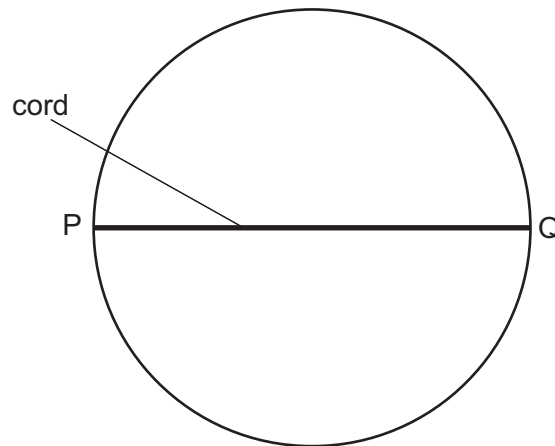

The midpoint of the cord is then pulled and fixed to a point on the ring halfway between P and Q.

What is the energy stored in the elastic cord?

- A  $\frac{1}{2}kr^2$   
B  $2kr^2$   
C  $\frac{1}{2}(\sqrt{2} - 1)kr^2$   
D  $2(\sqrt{2} - 1)kr^2$   
E  $\frac{1}{2}(3 - 2\sqrt{2})kr^2$   
F  $2(3 - 2\sqrt{2})kr^2$

- 14 An object of mass  $M$  experiences a resultant force of magnitude  $F$ . The force acts in a single horizontal direction with a magnitude that varies with time  $t$  according to

$$F = X + Y\sqrt{t}$$

where  $X$  and  $Y$  are constants.

The object is at rest at  $t = 0$ .

What is the magnitude of the momentum of the object at time  $t = T$ ?

- A  $T(X + \frac{2}{3}Y\sqrt{T})$   
B  $T(X + Y\sqrt{T})$   
C  $\frac{T}{M}(X + \frac{2}{3}Y\sqrt{T})$   
D  $\frac{T}{M}(X + Y\sqrt{T})$   
E  $\frac{Y}{2\sqrt{T}}$   
F  $\frac{Y}{2M\sqrt{T}}$

- 15** A trolley of mass 3.0 kg is moving horizontally along a smooth track. Its displacement  $x$  from a point at time  $t$  is given by the equation:

$$x = 8 + 4t + 2t^2$$

where  $x$  is in metres and  $t$  is in seconds.

How much work is done on the trolley between times  $t = 0$  and  $t = 5.0$  s?

- A** 12 J
- B** 24 J
- C** 78 J
- D** 270 J
- E** 840 J
- F** 864 J
- G** 936 J

- 16 The diagram shows a ray of light passing through three mediums, P, Q and R. The boundaries between the three mediums are parallel.

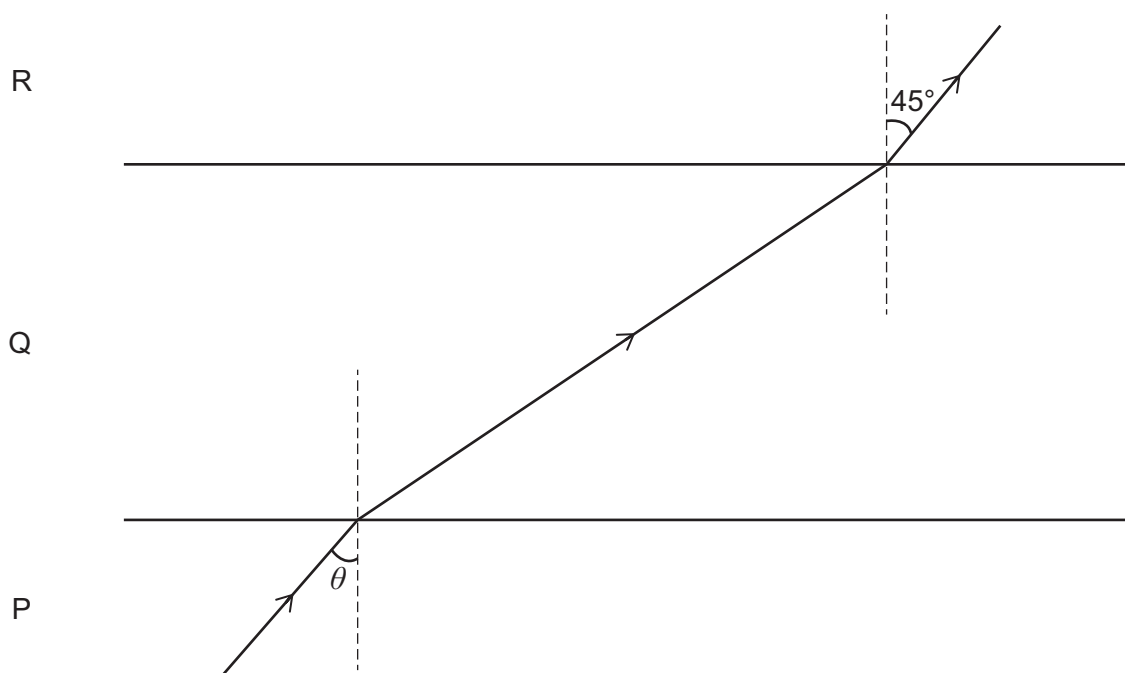

[diagram not to scale]

The ratio of the speed of light in medium P to the speed of light in medium Q is  $2 : \sqrt{5}$

The ratio of the speed of light in medium Q to the speed of light in medium R is  $3 : \sqrt{6}$

What is the value of  $\sin \theta$ ?

- A  $\frac{\sqrt{2}}{2}$   
 B  $\frac{\sqrt{3}}{2}$   
 C  $\frac{\sqrt{3}}{6}$   
 D  $\frac{\sqrt{5}}{5}$   
 E  $\frac{\sqrt{15}}{5}$   
 F  $\frac{\sqrt{15}}{6}$

- 17 Water in a wide river flows at a constant speed of  $0.50 \text{ m s}^{-1}$ . A swimmer swims around a square path of side  $30 \text{ m}$  marked out by 4 posts R, S, T and U which are fixed to the river bed, as shown.

The swimmer has a constant speed of  $1.0 \text{ m s}^{-1}$  relative to the water.

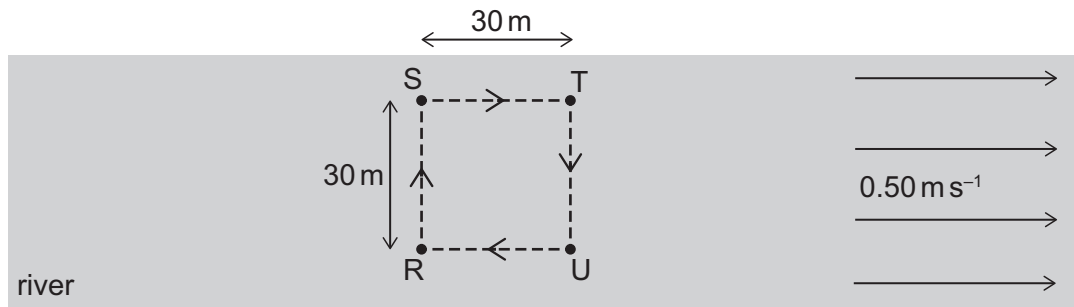

How long does it take for the swimmer to swim around the square path once?

- A  $(60 + 24\sqrt{5}) \text{ s}$
- B  $(60 + 40\sqrt{3}) \text{ s}$
- C  $(80 + 24\sqrt{5}) \text{ s}$
- D  $(80 + 40\sqrt{3}) \text{ s}$
- E  $120 \text{ s}$
- F  $140 \text{ s}$



- 18 The stress in a steel cable increases with time and is then maintained at a constant value, as shown. The wire does not reach its limit of proportionality.

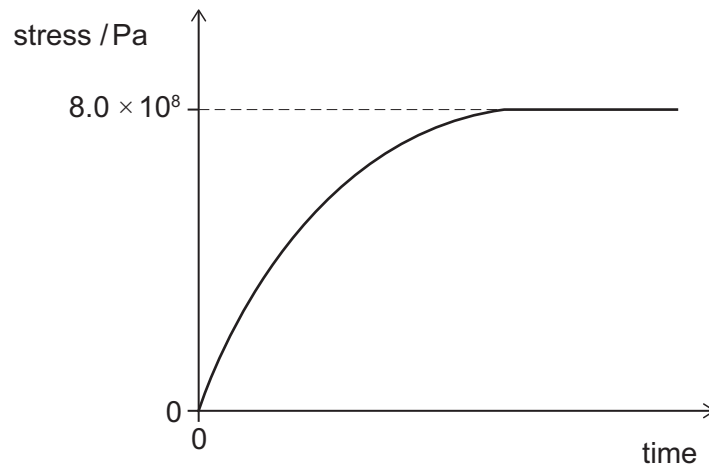

The table shows properties of the steel used in the cable and the dimensions of the cable.

<i>length / m</i>	<i>cross-sectional area / m<sup>2</sup></i>	<i>Young modulus / Pa</i>
4.0	$2.0 \times 10^{-4}$	$2.0 \times 10^{11}$

How much work was done to stretch the cable?

- A 320 J
- B 1.28 kJ
- C 2.56 kJ
- D 320 kJ
- E 640 kJ
- F 1.60 MJ
- G 6.40 MJ

- 19 The following graph shows how the displacement of an object travelling along a straight, horizontal track varies with time.

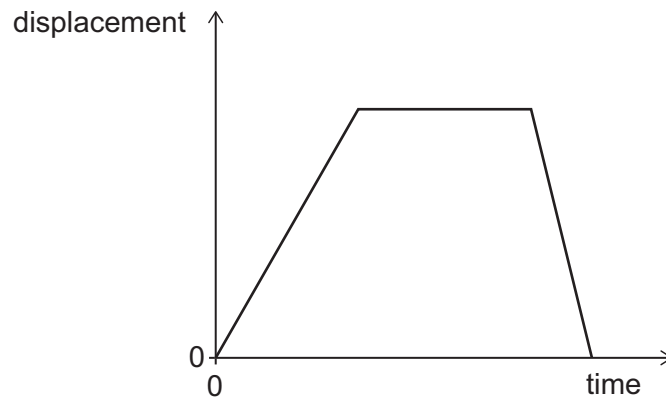

Which graph shows the velocity of this object against displacement?

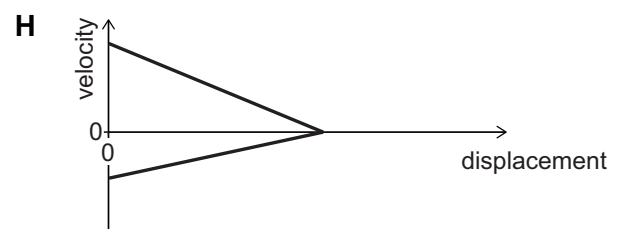
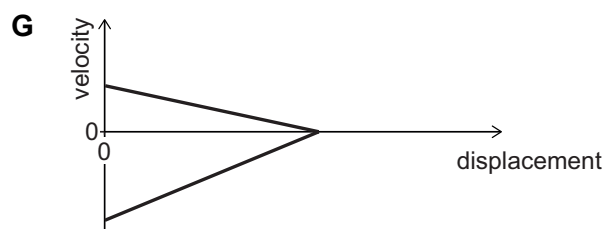
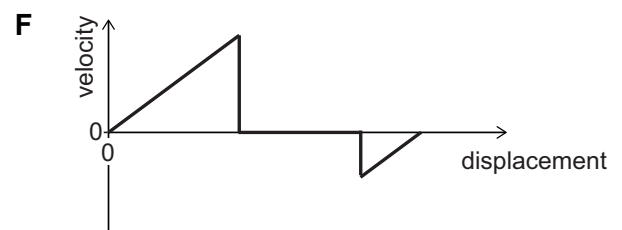
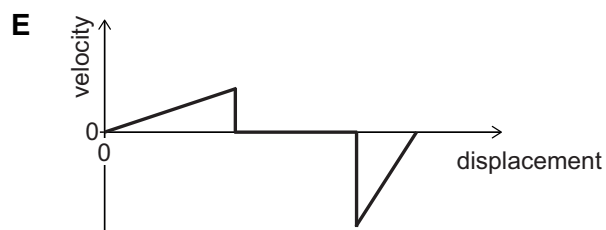
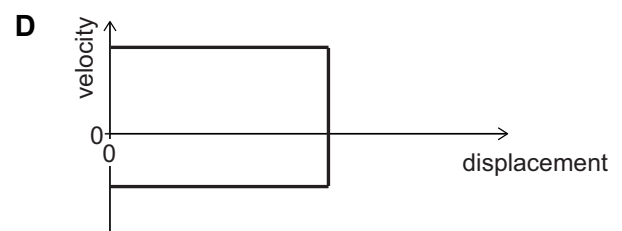
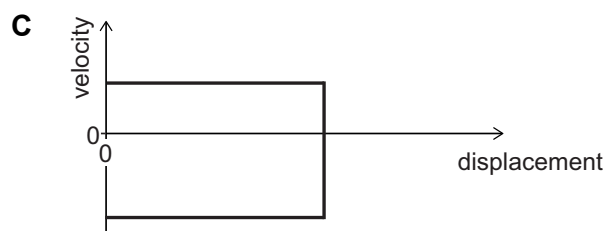
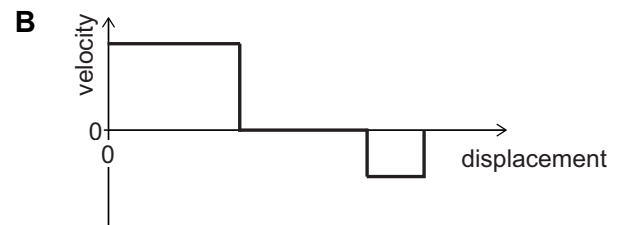
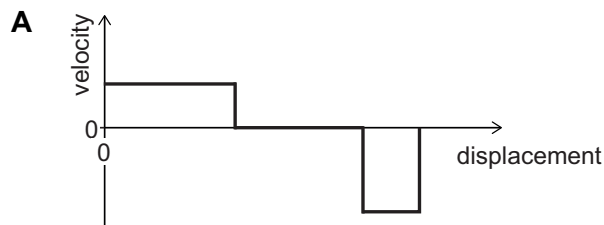

- 20 A cell has emf  $E$  and internal resistance  $r$  that varies with current  $I$  according to:

$$r = kI^2$$

where  $k$  is a constant.

A variable resistor is connected to the terminals of the cell. The resistance of the variable resistor is adjusted.

Which expression gives the resistance of the variable resistor, in terms of  $k$  and  $E$ , that causes maximum power dissipation in it?

**A**  $3\left(\frac{kE^2}{2}\right)^{\frac{1}{3}}$

**B**  $3\left(\frac{kE^2}{4}\right)^{\frac{1}{3}}$

**C**  $3\left(\frac{kE^2}{9}\right)^{\frac{1}{3}}$

**D**  $3\left(\frac{kE^2}{16}\right)^{\frac{1}{3}}$

**E**  $(2kE^2)^{\frac{1}{3}}$

**F**  $(4kE^2)^{\frac{1}{3}}$

**G**  $(9kE^2)^{\frac{1}{3}}$

**H**  $(16kE^2)^{\frac{1}{3}}$

**BLANK PAGE**

## **PART Y Chemistry**

- 21 The table gives standard enthalpy change data measured at 25 °C.

<i>reaction</i>	<i>standard enthalpy change / kJ mol<sup>-1</sup></i>
$\text{H(g)} + \text{Br(g)} \rightarrow \text{HBr(g)}$	-366
$\text{H(g)} + \text{Br(g)} \rightarrow \text{H}^{\text{+}}(\text{g}) + \text{Br}^{\text{-}}(\text{g})$	+968
$\text{HBr(g)} \rightarrow \text{H}^{\text{+}}(\text{aq}) + \text{Br}^{\text{-}}(\text{aq})$	-92

What is the standard enthalpy change for the following reaction at 25 °C?

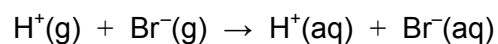

- A -510 kJ mol<sup>-1</sup>
- B +510 kJ mol<sup>-1</sup>
- C -694 kJ mol<sup>-1</sup>
- D +694 kJ mol<sup>-1</sup>
- E -1242 kJ mol<sup>-1</sup>
- F +1242 kJ mol<sup>-1</sup>
- G -1426 kJ mol<sup>-1</sup>
- H +1426 kJ mol<sup>-1</sup>

**22** Alpha-linolenic acid is a polyunsaturated straight-chain carboxylic acid.

0.001 mol of the acid reacts exactly with 15 cm<sup>3</sup> of 0.2 mol dm<sup>-3</sup> aqueous bromine.

Alpha-linolenic acid contains 18 carbon atoms per molecule.

Which of the following is a formula for the acid?

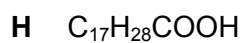
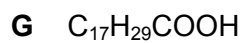
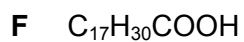
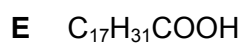
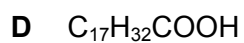
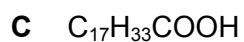
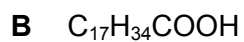
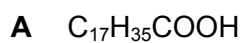

- 23** 25.0 g of compound X contains 9.75 g of potassium, 0.25 g of hydrogen and 12.0 g of oxygen.

When heated strongly, compound X produces a gas that turns limewater cloudy.

The chemical formula of X is the same as its empirical formula.

Compound X is the only product formed between substance Y and two further substances. One of these is the fourth most abundant gas in clean dry air, and the other changes the colour of anhydrous copper(II) sulfate from white to blue.

Which of the following could be the identity of substance Y?

( $A_r$  values: H = 1; C = 12; O = 16; K = 39)

- A** K
- B**  $K_2CO_3$
- C**  $K_2O_3$
- D**  $KHCO_3$
- E**  $CH_3COOK$



**24** Strontium (Sr) is a Group 2 metal.

Strontium hydride is an ionic compound made up of strontium and hydrogen only.

When a small mass of strontium hydride is added to 180 g of water in an insulated container and stirred, the temperature of the water rises by 25 °C and hydrogen gas is given off.

Assume that:

- the standard enthalpy change of the reaction is  $-360 \text{ kJ mol}^{-1}$  of strontium hydride.
- the specific heat capacity of water (and the solution formed) is  $4 \text{ J g}^{-1} \text{ }^\circ\text{C}^{-1}$ . Ignore any change in mass of the water due to the reaction.
- all heat is transferred to the water only.
- all measurements are made at atmospheric pressure, with all reactants and products in their standard states.
- one mole of a gas occupies  $24 \text{ dm}^3$  at room temperature and pressure.

What is the maximum volume of hydrogen (measured at room temperature) that could be released?

- A**  $1.20 \text{ dm}^3$
- B**  $1.80 \text{ dm}^3$
- C**  $2.40 \text{ dm}^3$
- D**  $240 \text{ dm}^3$
- E**  $480 \text{ dm}^3$
- F**  $2400 \text{ dm}^3$

- 25** Element X forms the most soluble hydroxide of the hydroxides of the Group 2 elements in the range Mg to Ba.

50 cm<sup>3</sup> of a 0.2 mol dm<sup>-3</sup> aqueous solution of an acid Y is exactly neutralised by 400 cm<sup>3</sup> of a 0.05 mol dm<sup>-3</sup> aqueous solution of potassium hydroxide.

100 cm<sup>3</sup> of a 0.1 mol dm<sup>-3</sup> aqueous solution of Y is titrated with an aqueous solution of the hydroxide of X until the acid is exactly neutralised.

Which statement about one product of the titration could be correct?

- A** 0.005 mol of barium chloride is formed.
- B** 0.05 mol of barium chloride is formed.
- C** 0.005 mol of magnesium chloride is formed.
- D** 0.05 mol of magnesium chloride is formed.
- E** 0.01 mol of barium sulfate is formed.
- F** 0.1 mol of barium sulfate is formed.
- G** 0.01 mol of magnesium sulfate is formed.
- H** 0.1 mol of magnesium sulfate is formed.

- 26** In the presence of a suitable catalyst,  $30.0 \text{ cm}^3$  of a  $0.10 \text{ mol dm}^{-3}$  aqueous solution of  $\text{Na}_2\text{C}_2\text{O}_4$  reacts exactly with  $40.0 \text{ cm}^3$  of a  $0.15 \text{ mol dm}^{-3}$  aqueous solution of  $\text{Ce}(\text{SO}_4)_2$ .

The only products of the reaction are another cerium salt, a different water-soluble salt and carbon dioxide.

What is the cerium ion formed by this reaction?

- A**  $\text{Ce}^+$
- B**  $\text{Ce}^{2+}$
- C**  $\text{Ce}^{3+}$
- D**  $\text{Ce}^{4+}$
- E**  $\text{Ce}^{5+}$

- 27 Consider all of the structural isomers of  $C_4H_9Br$  and the ways that they could react with hydroxide ions from aqueous sodium hydroxide.

How many different organic products (including all structural and *E/Z* isomers only) containing four carbons could be made?

- A 4
- B 5
- C 6
- D 7
- E 8
- F 9

- 28** In which of the following conversions does the stated bond angle decrease?
- 1** hydrogen–nitrogen–hydrogen bond angle in the conversion from  $\text{NH}_3$  to  $\text{NH}_4^+$
  - 2** fluorine–iodine–fluorine bond angle in the conversion from  $\text{IF}_4^-$  to  $\text{IF}_6^+$
  - 3** chlorine–aluminium–chlorine bond angle in the conversion from  $\text{AlCl}_3$  to  $\text{AlCl}_4^-$
- A** none of them
- B** 1 only
- C** 2 only
- D** 3 only
- E** 1 and 2 only
- F** 1 and 3 only
- G** 2 and 3 only
- H** 1, 2 and 3

- 29 Ethanol combines with ethanoic acid to form ethyl ethanoate according to the following reaction.

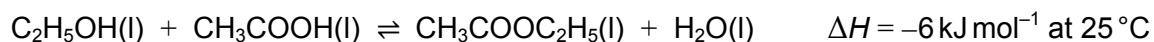

A mixture of 9.2 g ethanol, 12 g ethanoic acid and 8.8 g ethyl ethanoate is allowed to react and reach equilibrium.

The resulting equilibrium mixture is found to contain 4.8 g ethanoic acid at 25 °C and  $K_c$  was calculated.

What will happen to the value of  $K_c$  when the temperature is increased from 25 °C to 45 °C?

( $M_r$  values:  $\text{C}_2\text{H}_5\text{OH} = 46$ ;  $\text{CH}_3\text{COOH} = 60$ ;  $\text{CH}_3\text{COOC}_2\text{H}_5 = 88$ ;  $\text{H}_2\text{O} = 18$ )

- A It increases from an initial value of 0.242
- B It decreases from an initial value of 0.242
- C It increases from an initial value of 1.833
- D It decreases from an initial value of 1.833
- E It increases from an initial value of 2.750
- F It decreases from an initial value of 2.750
- G It increases from an initial value of 4.125
- H It decreases from an initial value of 4.125

- 30 Compound Z is known to have percentage composition by mass C: 80.0%, H: 6.7%, O: 13.3%. The mass spectrum of compound Z is given showing the mass-to-charge ratio ( $m/z$ ) of the molecular ion and its fragments.

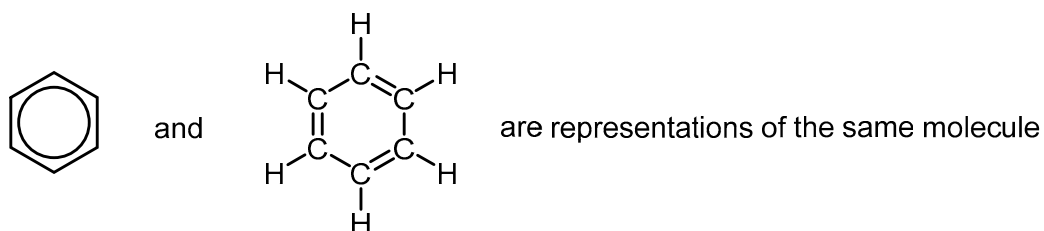
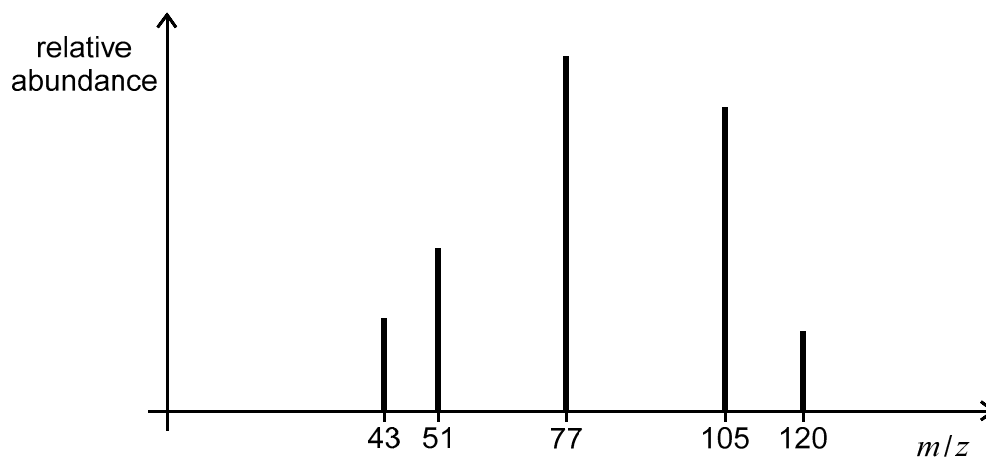

Which of the following could be the structure of Z?

( $A_r$  values: C = 12; H = 1; O = 16)

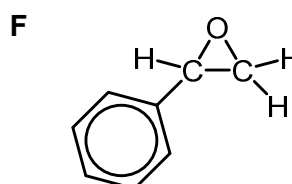
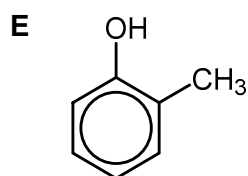
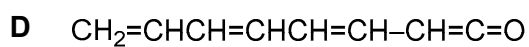
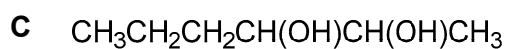
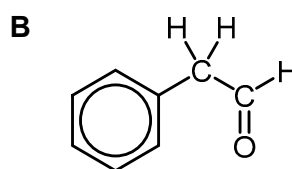
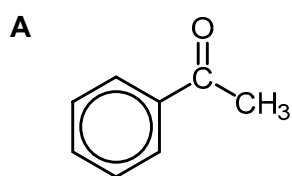

- 31 The time it takes the ion  ${}^1_1\text{H}^+$  to travel through the flight tube in a time-of-flight mass spectrometer is  $t$ .

How long would it take the ion  ${}^2_1\text{H}^+$  to travel through the same flight tube?

- A  $\frac{1}{4}t$
- B  $\frac{1}{2}t$
- C  $\frac{1}{\sqrt{2}}t$
- D  $\sqrt{\frac{2}{3}}t$
- E  $\sqrt{\frac{3}{2}}t$
- F  $\sqrt{2}t$
- G  $2t$
- H  $4t$



- 32 A paper coffee cup is lined with a thin layer of plastic to make it waterproof. This plastic makes up 5% of the mass of the cup and has the following molecular structure.

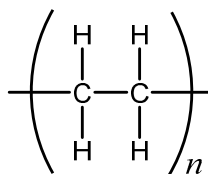

960 dm<sup>3</sup> of a gaseous hydrocarbon monomer (measured at room temperature and pressure) was used to make a certain number of plastic-lined cups.

It is proposed that a more environmentally-friendly, biodegradable plastic, poly(lactic acid), could be used instead in the same proportions by mass (5%). Assume that any polymerisation reaction has a 100% yield.

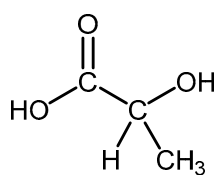

lactic acid

What mass of lactic acid ( $M_r = 90$ ) is required to make the same number of biodegradable cups?

( $A_r$  values: H = 1; C = 12; O = 16. Assume that one mole of a gas occupies 24 dm<sup>3</sup> at room temperature and pressure.)

- A 896 g
- B 1120 g
- C 1200 g
- D 1400 g
- E 1500 g
- F 3000 g
- G 3600 g

- 33** In which of the following pairs do **both** molecules possess permanent dipoles in the gaseous state?
- 1** methylamine ( $\text{CH}_3\text{NH}_2$ ) and dichlorine monoxide ( $\text{Cl}_2\text{O}$ )
  - 2** difluoroethyne ( $\text{C}_2\text{F}_2$ ) and sulfur hexafluoride
  - 3** phosphorus trichloride and xenon tetrafluoride
- A** none of them
- B** 1 only
- C** 2 only
- D** 3 only
- E** 1 and 2 only
- F** 1 and 3 only
- G** 2 and 3 only
- H** 1, 2 and 3

- 34 At high temperatures, carbon dioxide reacts partially with solid carbon and forms the following equilibrium.

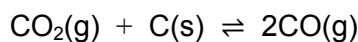

In an experiment, 1.0 mol of carbon dioxide is placed in a flask of capacity  $V\text{dm}^3$  containing no air and an excess of carbon. It is then heated to a high temperature where an equilibrium between carbon dioxide and carbon monoxide is established. At this temperature,  $x$  mol of carbon dioxide converts to carbon monoxide and the value of the equilibrium constant,  $K_c$ , is  $2.0\text{mol dm}^{-3}$ .

As it is a solid, carbon is not included in the equilibrium constant expression.

What is the relationship between the value of  $x$  and  $V$ ?

A  $x = \frac{-V + \sqrt{V^2 + 32V}}{16}$

B  $x = \frac{-V + \sqrt{V^2 + 8V}}{4}$

C  $x = \frac{-2 + \sqrt{4V^2 + 8V}}{4}$

D  $x = \frac{-2V + \sqrt{4V^2 - 2V}}{2}$

E  $x = \frac{-2 + \sqrt{4 - 32V}}{4V}$

- 35** A student carried out an experiment to find the mass of the active ingredient calcium carbonate ( $M_r = 100$ ) in an indigestion tablet. The student crushed the tablet and placed it in a beaker.

The student added  $20.0 \text{ cm}^3$  of  $2.00 \text{ mol dm}^{-3}$  hydrochloric acid, an excess, to the tablet. When the reaction was complete, the reaction mixture was all transferred to a volumetric flask and deionised water added to make the solution up to  $250 \text{ cm}^3$ .

$25.0 \text{ cm}^3$  samples of the solution in the volumetric flask were titrated against  $0.100 \text{ mol dm}^{-3}$  sodium hydroxide solution. The mean titre was  $26.40 \text{ cm}^3$  of sodium hydroxide solution.

Assuming that all other ingredients in the tablet are inert, what is the mass of calcium carbonate in the tablet?

- A** 0.264 g
- B** 0.680 g
- C** 1.36 g
- D** 1.87 g
- E** 2.72 g

- 36** Ellingham diagrams show how the quantity  $\Delta G$  for a reaction varies over a range of temperatures.

The  $\Delta G$  values for different reactions can be combined using Hess's law.

For a reaction to be able to occur, the overall value of  $\Delta G$  must be less than zero.

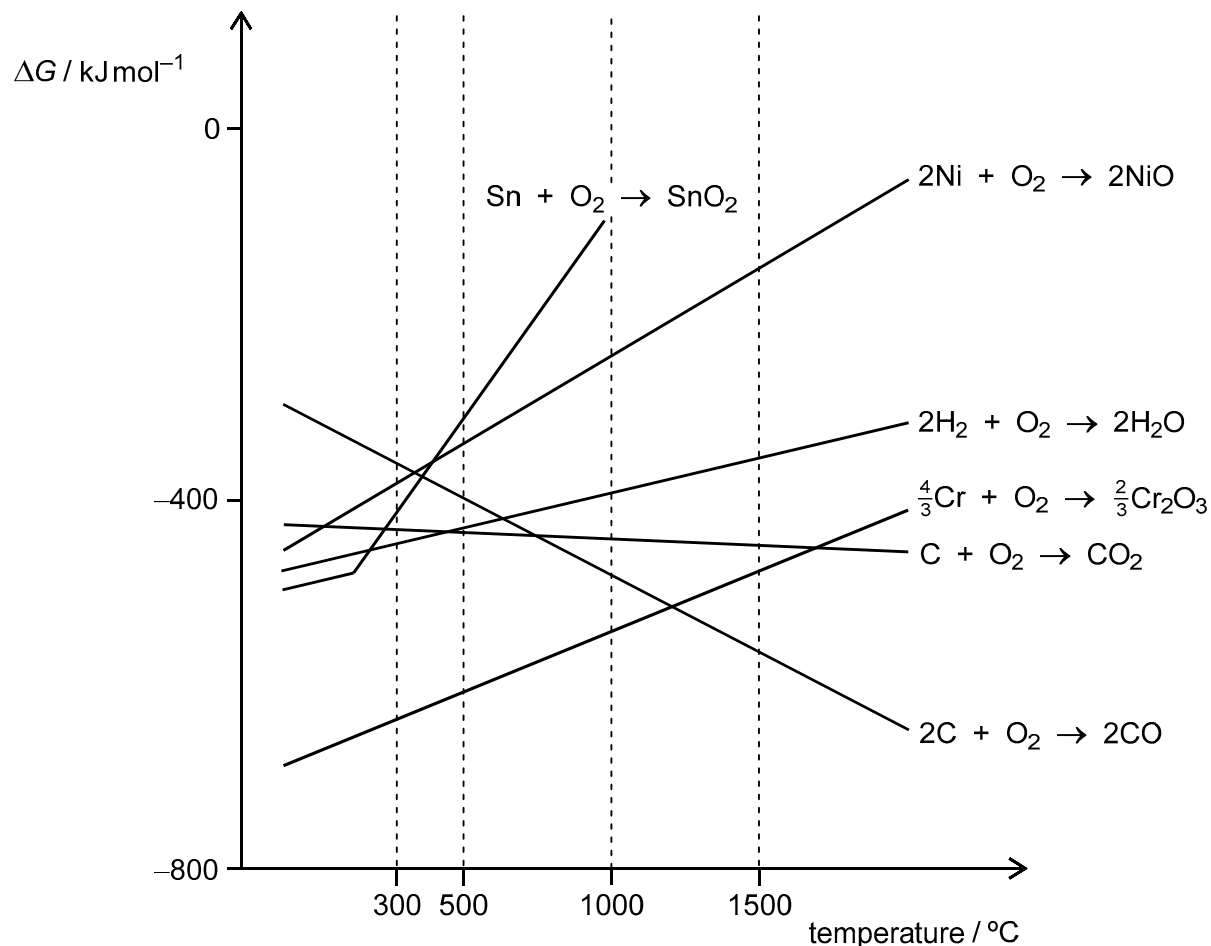

Using the Ellingham diagram shown, which one of the following statements is correct?

- A** Nickel can reduce tin(IV) oxide at 300 °C.
- B** Carbon can reduce chromium(III) oxide at 1500 °C forming carbon dioxide and chromium.
- C** Chromium(III) oxide and nickel oxide will decompose to their elements at all the temperatures shown.
- D** Chromium will react with steam at all the temperatures shown.
- E** Nickel oxide can be reduced by carbon at 300 °C forming carbon monoxide and nickel.

- 37**  $\text{SO}_3^{2-}(\text{aq})$  ions can cause the reduction of  $\text{VO}_3^-(\text{aq})$  ions to  $\text{VO}^{2+}(\text{aq})$  in acidic solution. During this process, the  $\text{SO}_3^{2-}(\text{aq})$  ions are oxidised to  $\text{SO}_4^{2-}(\text{aq})$  ions.

What is the minimum volume of  $1.00 \text{ mol dm}^{-3}$  sulfuric acid required to provide sufficient hydrogen ions to allow  $\text{Na}_2\text{SO}_3(\text{aq})$  to reduce  $40.0 \text{ cm}^3$  of  $0.100 \text{ mol dm}^{-3}$   $\text{VO}_3^-(\text{aq})$  ions completely to  $\text{VO}^{2+}(\text{aq})$ ?

- A** no sulfuric acid is required
- B**  $4.0 \text{ cm}^3$
- C**  $6.0 \text{ cm}^3$
- D**  $6.6 \text{ cm}^3$
- E**  $8.0 \text{ cm}^3$
- F**  $12.0 \text{ cm}^3$
- G**  $13.2 \text{ cm}^3$

- 38 Sodium chloride is an ionic compound which forms highly ordered crystals of ions when in the solid state. This is called a lattice.

A lattice can be thought of as a stack of layered planes of ions.

In the following diagrams, the shaded and non-shaded circles represent sodium and chloride ions, respectively.

Which of the following is **not** a representation of a plane present in a sodium chloride lattice?

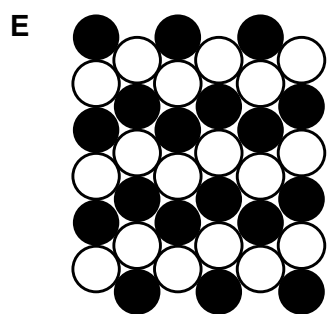
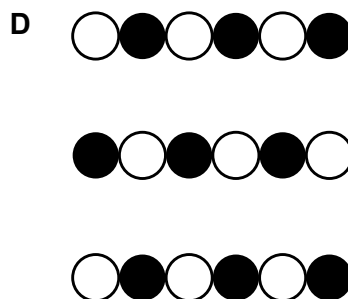
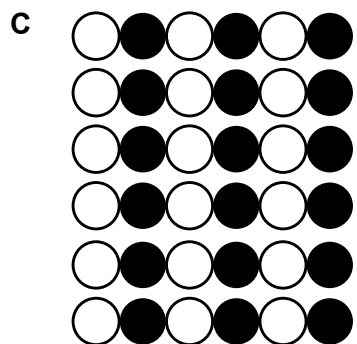
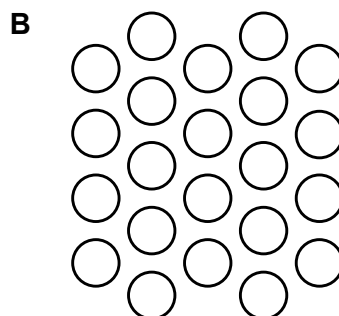
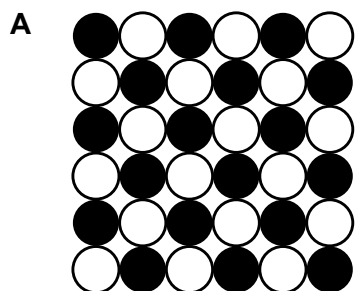

- 39 When bromine reacts with (*Z*)-pent-2-ene, an intermediate called a bromonium ion forms. This is then attacked by the bromide ion to give the 2,3-dibromopentane addition product.

The mechanism is shown:

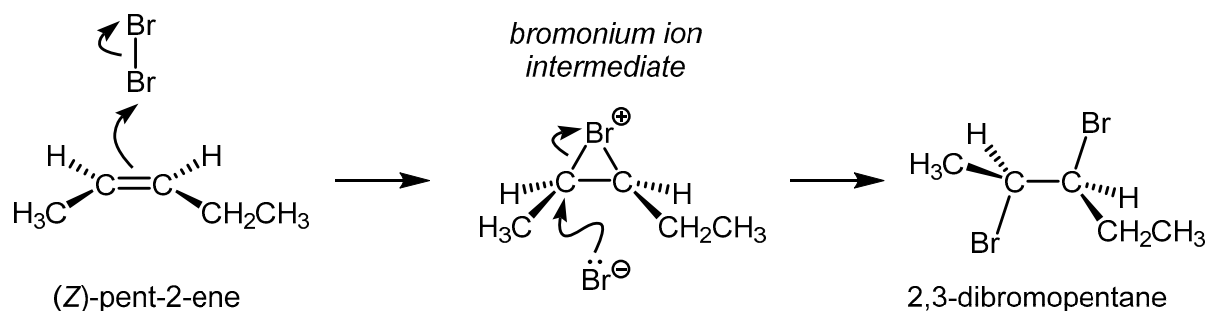

In a different reaction (*E*)-but-2-ene is reacted with bromine in an addition reaction. This reaction also occurs via a bromonium ion intermediate.

Which of the following structures show the final product of the reaction of (*E*)-but-2-ene with bromine?

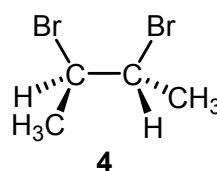
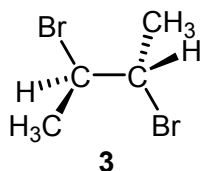
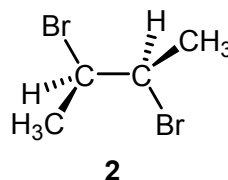
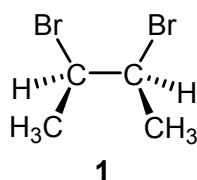

- A structures 1 and 2 only  
 B structures 1 and 3 only  
 C structures 1 and 4 only  
 D structures 2 and 3 only  
 E structures 2 and 4 only  
 F structures 3 and 4 only  
 G structures 1, 2, 3 and 4



- 40** Both oxygen and carbon monoxide bind reversibly to haemoglobin.

For the purposes of this question, assume that only one molecule of either oxygen or carbon monoxide can bind to haemoglobin at any one time.

Within the human body, carbon monoxide is 200 times more effective than oxygen in binding to haemoglobin available in human blood. The *binding efficiency* is the equilibrium constant for this process and you may assume that the system is at equilibrium.

The effects of carboxy-haemoglobin in humans can typically be observed when it reaches 5% of the concentration of oxy-haemoglobin in their blood.

Assume that oxygen and carbon monoxide have the same molar solubility in blood.

What is the minimum proportion of carbon monoxide molecules in dry air, expressed as parts per million (ppm), that will result in a 5% ratio of carboxy-haemoglobin molecules to oxy-haemoglobin molecules in blood?

- A 10 ppm
- B 21 ppm
- C 52.5 ppm
- D 210 ppm
- E 1000 ppm
- F 5250 ppm

**BLANK PAGE**

## **PART Z Biology**

- 41 The diagram shows the inheritance of a characteristic controlled by a single gene. Two organisms reproduce sexually and have four offspring, one offspring at a time.

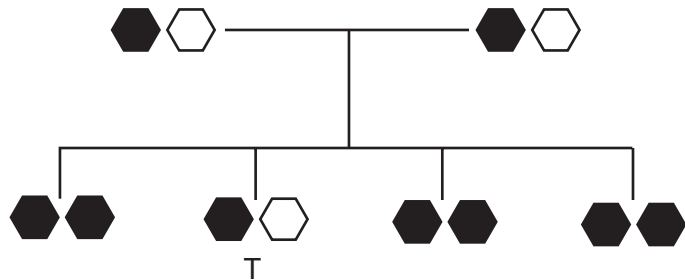
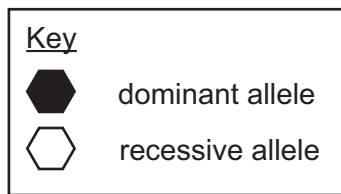

Individual T goes on to have a single offspring with an unrelated individual who has a recessive phenotype. The offspring of T has a dominant phenotype.

What is the ratio of dominant to recessive alleles for all of the individuals in this diagram, as well as T's mate and their one offspring?

- A 3:5
- B 5:3
- C 7:1
- D 1:7
- E 3:1
- F 1:3
- G 2:1
- H 1:2

- 42 The average healthy mature red blood cell contains 200 000 000 molecules of haemoglobin.

If a red blood cell is saturated with dissolved oxygen, each haemoglobin molecule carries a total of 4 molecules of oxygen.

Haemoglobin molecules in red blood cells in the pulmonary artery are on average 65% saturated with oxygen.

How many oxygen molecules are carried by the average red blood cell in the pulmonary artery, and is the level of oxygen saturation greater in the aorta or the pulmonary artery?

	<i>number of oxygen molecules carried</i>	<i>level of oxygen saturation</i>
<b>A</b>	$8.0 \times 10^8$	aorta > pulmonary artery
<b>B</b>	$8.0 \times 10^8$	aorta < pulmonary artery
<b>C</b>	$5.2 \times 10^8$	aorta > pulmonary artery
<b>D</b>	$5.2 \times 10^8$	aorta < pulmonary artery
<b>E</b>	$2.8 \times 10^8$	aorta > pulmonary artery
<b>F</b>	$2.8 \times 10^8$	aorta < pulmonary artery
<b>G</b>	$1.3 \times 10^8$	aorta > pulmonary artery
<b>H</b>	$1.3 \times 10^8$	aorta < pulmonary artery

- 43 Graphs P and Q were plotted using data collected in an investigation into the effect of temperature from 0 to 60 °C on an enzyme-controlled reaction. All other variables were controlled.

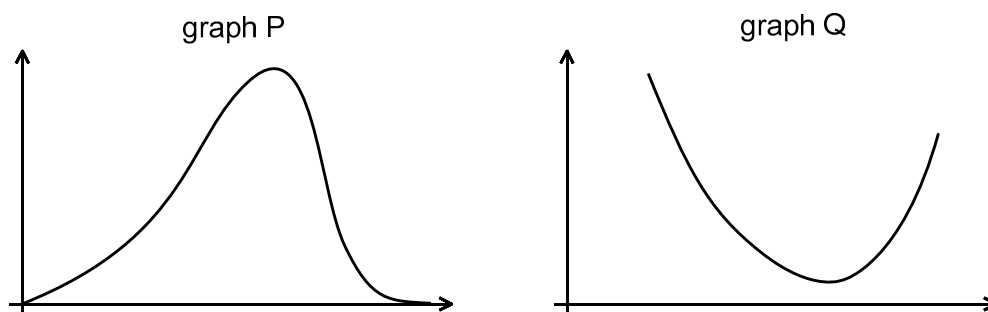

Which two rows correctly identify the variables plotted on the horizontal and vertical axes of these graphs?

<i>row</i>	<i>graph</i>	<i>horizontal axis</i>	<i>vertical axis</i>
1	P	temperature	time taken for reaction
2	P	temperature	rate of reaction
3	P	time taken for reaction	temperature
4	P	time taken for reaction	rate of reaction
5	Q	temperature	time taken for reaction
6	Q	temperature	rate of reaction
7	Q	time taken for reaction	temperature
8	Q	time taken for reaction	rate of reaction

- A** 1 and 6  
**B** 1 and 7  
**C** 2 and 5  
**D** 2 and 6  
**E** 3 and 5  
**F** 3 and 8  
**G** 4 and 7  
**H** 4 and 8

- 44** A recessive condition is found within a human population. There were 5000 births in this population within one year. Of these births, 8% had the condition and 32% were homozygous dominant.

One healthy cheek cell is analysed from each person born in this year.

How many recessive alleles and dominant alleles are present?

(Assume that no new mutations occur.)

	<i>recessive alleles</i>	<i>dominant alleles</i>
<b>A</b>	400	1600
<b>B</b>	400	4600
<b>C</b>	3400	1600
<b>D</b>	3400	4600
<b>E</b>	3400	6200
<b>F</b>	3800	1600
<b>G</b>	3800	4600
<b>H</b>	3800	6200

- 45** A study was carried out into the effect of liver protein Z on the risk of developing coronary heart disease, which is often associated with high blood cholesterol. Z binds to another protein in the membrane of liver cells that transports cholesterol from the blood into cells. This binding blocks the function of the transport protein.

Blood cholesterol levels were measured in three different groups of people. One group was a control group and contained no mutations in the gene for Z. The second group all had the same mutation in the gene (called mutation 1). This mutation occurs in the final section of the gene. A third group all had a different mutation in the gene (called mutation 2), but this was in the first section of the gene. The results are shown in the graph.

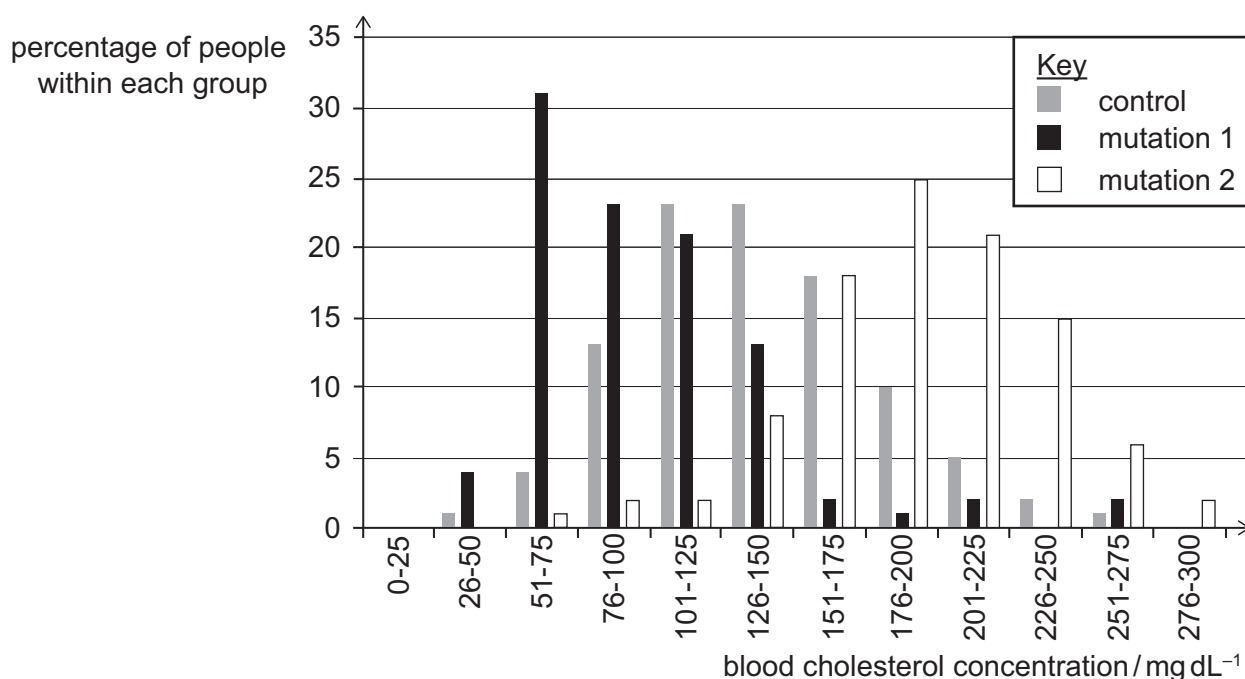

Which of the following can be correctly concluded from these results?

- 1 Changes in the first section of protein Z stop it from binding to the cholesterol transport protein.
  - 2 Mutation 1 could result in an increase in the concentration of cholesterol inside liver cells.
  - 3 Of the three groups, people in the control group are least likely to develop coronary heart disease.
- A** none of them
- B** 1 only
- C** 2 only
- D** 3 only
- E** 1 and 2 only
- F** 1 and 3 only
- G** 2 and 3 only
- H** 1, 2 and 3



- 46 Equal-sized, rectangular blocks of a raw potato were cut and their mass measured. The blocks were then placed in equal volumes of different concentrations of sucrose solutions for the same length of time. All other variables were kept constant.

After this time, the blocks were blotted on paper and then their masses were measured again. The percentage change in mass of each block was calculated and the results are shown in the graph.

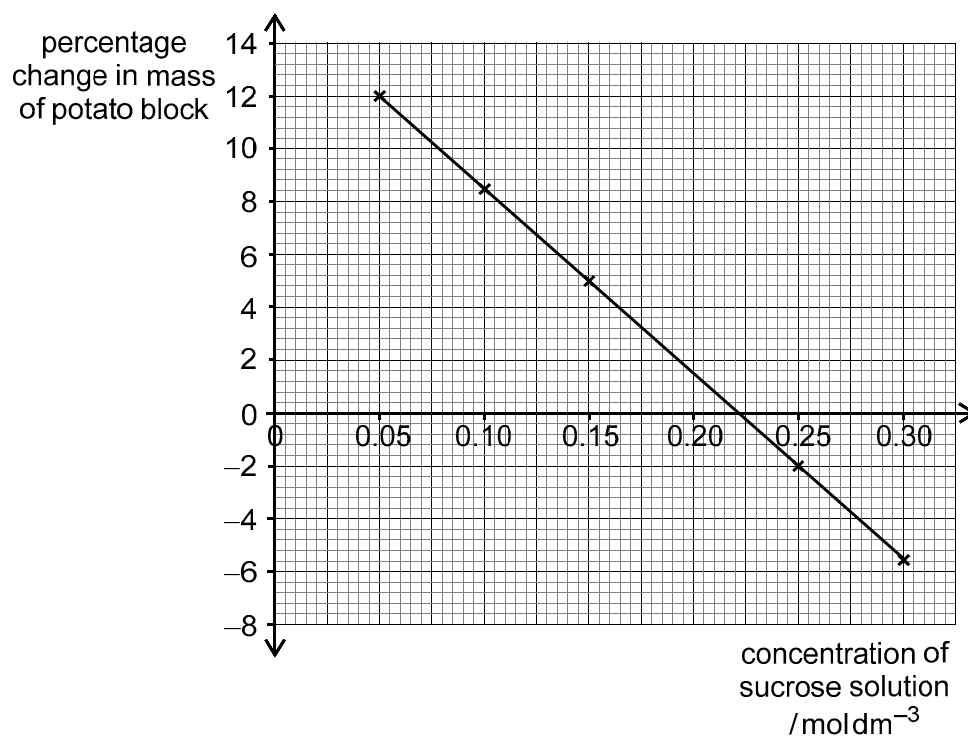

Which of the following statements is/are correct?

- 1 In 0.10 mol dm<sup>-3</sup> sucrose solution, there was some movement of sucrose molecules by osmosis across the membrane out of the potato block.
  - 2 If the initial mass of the block in 0.25 mol dm<sup>-3</sup> sucrose solution is 1.800 g then its final mass will be 1.764 g.
  - 3 Repeating the experiment at a temperature that was 10°C lower should not affect the point at which the graph crosses the *x*-axis.
- A none of them
- B 1 only
- C 2 only
- D 3 only
- E 1 and 2 only
- F 1 and 3 only
- G 2 and 3 only
- H 1, 2 and 3

- 47 The table shows the sources of water lost in one particular day from a healthy human.

<i>percentage of the water that is lost</i>	<i>source</i>
16	exhaled air
4	faeces
20	sweat
60	urine

On another day, the percentage of water lost in urine decreased by a sixth.

The percentage of water lost in exhaled air and in faeces remained the same.

The total volume of water lost was 2500 cm<sup>3</sup> on both days.

What is the percentage increase in the volume of sweat produced and the reason for the decrease in the volume of urine?

	<i>percentage increase in the volume of sweat</i>	<i>reason for the decrease in the volume of urine</i>
<b>A</b>	33	a decrease in ADH
<b>B</b>	33	an increase in ADH
<b>C</b>	50	a decrease in ADH
<b>D</b>	50	an increase in ADH
<b>E</b>	150	a decrease in ADH
<b>F</b>	150	an increase in ADH

- 48 The diagram shows the production of sperm cells in a healthy mammal. Cell P divides. One daughter cell goes on to replace cell P, and the other daughter cell is called Q in the diagram.

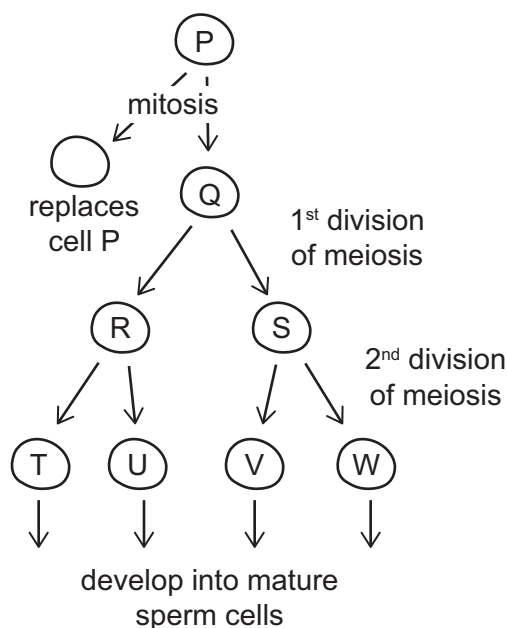

Each mitotic cell cycle takes 14 hours.

The diploid number of chromosomes in this mammal is 68.

Which of the following statements is/are correct?

- 1 Cell P is a type of stem cell.
  - 2 Cells T, U, V and W each contain 23 chromosomes.
  - 3 In 112 hours, 128 replacements of cell P are made.
- A** none of them
- B** 1 only
- C** 2 only
- D** 3 only
- E** 1 and 2 only
- F** 1 and 3 only
- G** 2 and 3 only
- H** 1, 2 and 3

- 49** In the disease emphysema the walls of the alveoli break down so that several smaller alveoli fuse to form a single large alveolus.

The diagram shows a model of the effect of emphysema on spherical alveoli.

radius of each alveolus =  $x$

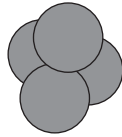

4 healthy alveoli

radius of alveolus =  $2x$

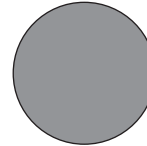

1 alveolus from a person with emphysema

Which of the following statements is/are correct?

- 1** The surface area-to-volume ratio of the four healthy alveoli is twice that of the single emphysema alveolus.
- 2** For the same concentration gradient, the rate of diffusion of oxygen into the blood from a single healthy alveolus will be greater than for a single emphysema alveolus.
- 3** Oxygen molecules will only move across the alveolus wall from the inside to the outside of an alveolus.

(surface area of a sphere =  $4\pi r^2$ ; volume of a sphere =  $\frac{4}{3}\pi r^3$ , where  $r$  is the radius)

- A** none of them
- B** 1 only
- C** 2 only
- D** 3 only
- E** 1 and 2 only
- F** 1 and 3 only
- G** 2 and 3 only
- H** 1, 2 and 3

- 50 Experiments were carried out to investigate the rate at which products were formed by two digestive enzymes, P and Q over a period of 30 minutes.

P and Q have similar optimum conditions for function. Only the enzyme and its substrate were changed between each reaction.

The results are shown in the graphs.

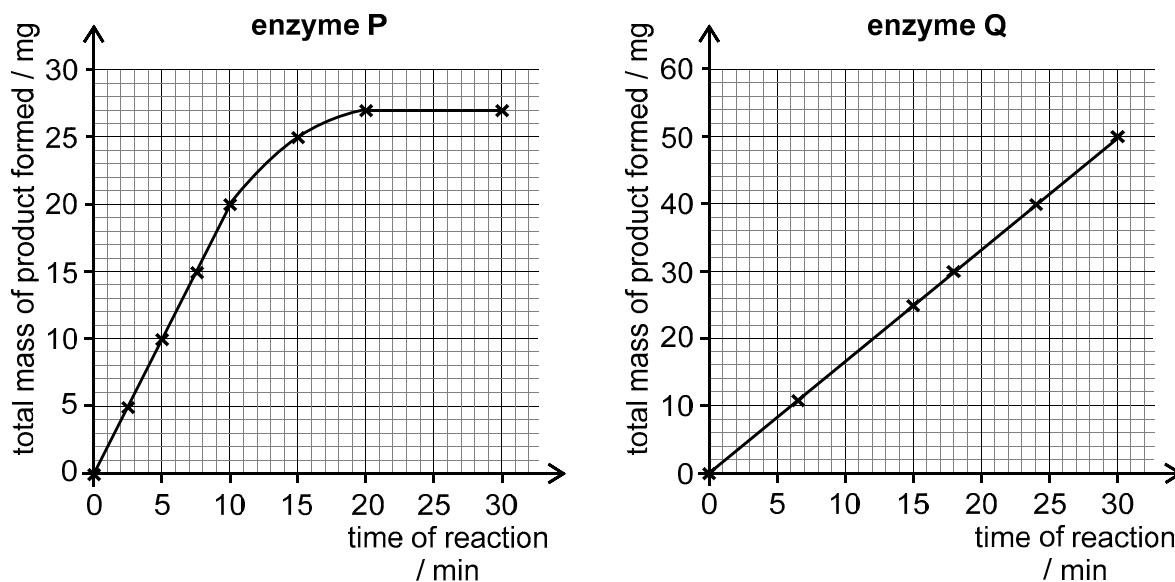

Which of the following statements is/are correct?

- 1 During the first 10 minutes, the rate of reaction ( $\text{mg min}^{-1}$ ) with enzyme P is double the rate with enzyme Q.
  - 2 A possible explanation for the difference in the shape between the graphs is that the product of the reaction catalysed by P significantly alters the pH of the solution.
  - 3 The percentage change in mass of product formed by enzyme Q is more than 5 times greater between 6.5 and 15 minutes than it is between 24 and 29 minutes.
- A none of them
- B 1 only
- C 2 only
- D 3 only
- E 1 and 2 only
- F 1 and 3 only
- G 2 and 3 only
- H 1, 2 and 3

- 51** An experiment was performed to investigate whether capillary action could account for the movement of water from roots to leaves in a plant.

The diagram shows apparatus used to model this effect using narrow glass capillary tubing. The inner diameter of the capillary tubing is 0.5 mm.

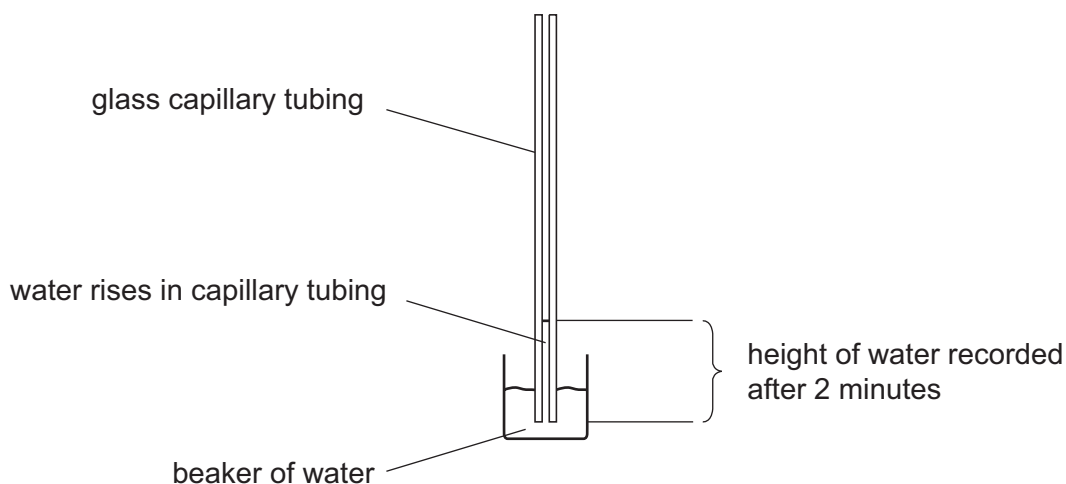

The initial height of the water in the tubing was recorded as 0.2 cm. After 2 minutes the height was recorded as 1.8 cm.

The model assumes the rate of movement is constant.

What is the rate of water movement in  $\text{mm}^3 \text{min}^{-1}$  and what vessel type transfers water from roots to leaves in a real plant?

	<i>rate of water movement / <math>\text{mm}^3 \text{min}^{-1}</math></i>	<i>vessel type</i>
<b>A</b>	$0.5\pi$	xylem
<b>B</b>	$0.5\pi$	phloem
<b>C</b>	$\pi$	xylem
<b>D</b>	$\pi$	phloem
<b>E</b>	$2\pi$	xylem
<b>F</b>	$2\pi$	phloem
<b>G</b>	$4\pi$	xylem
<b>H</b>	$4\pi$	phloem

- 52 Two healthy human cells with no mutations were modelled as shown in the diagrams below. The cells were not dividing. Both cells contain a single nucleus and are diploid.

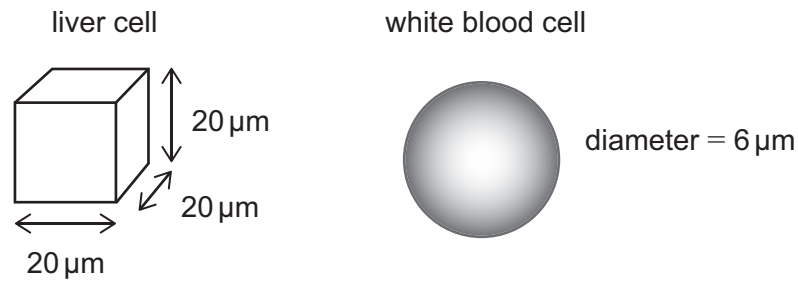

[diagram not to scale]

A study estimates that mitochondria account for 12% of the volume of both types of cells.

Using this estimate for all cells, which of the following is/are correct?

(The volume of a sphere is given by  $\frac{4}{3}\pi r^3$ , where  $r$  is the radius. Use the value 3.14 for  $\pi$ )

- 1 The larger number of mitochondria in the liver cell will produce more lactic acid than those in the white blood cell.
  - 2 The liver cell is larger and so will contain a greater mass of nuclear DNA than the white blood cell.
  - 3 The mitochondria in the white blood cell occupy  $14 \mu\text{m}^3$  to the nearest whole number.
- A none of them
- B 1 only
- C 2 only
- D 3 only
- E 1 and 2 only
- F 1 and 3 only
- G 2 and 3 only
- H 1, 2 and 3

- 53** Bacterial cells were grown in a laboratory experiment and the number of cells was recorded at regular intervals. The bacteria in this experiment reproduced asexually using a form of cell division. The growth medium was sterilised before it was used and the vessel containing the bacterial cells was sealed so that no other cells could enter.

The graph shows the results of the experiment.

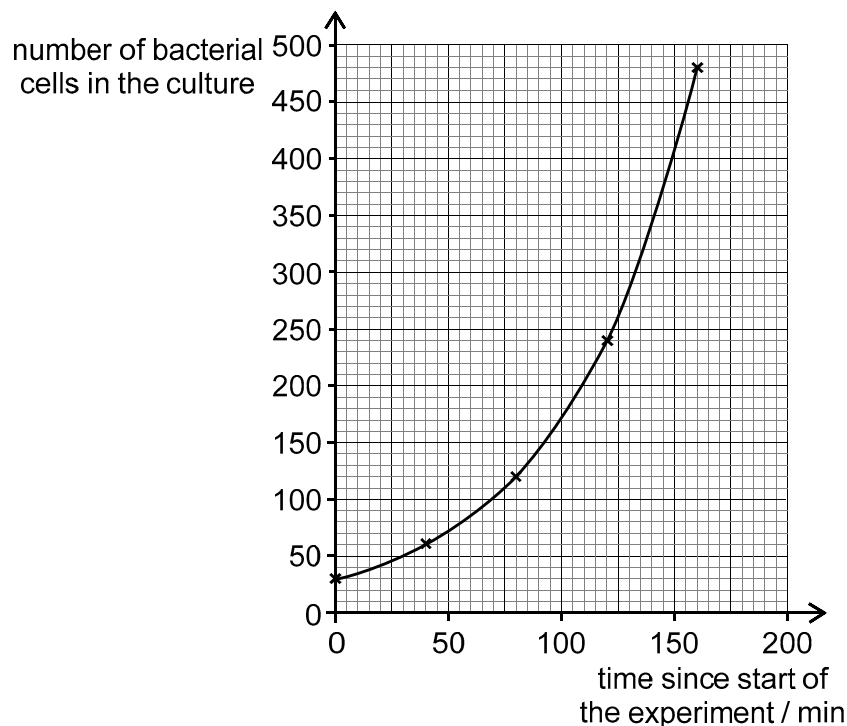

Which of the following statements is/are correct?

- 1 After 4 hours, assuming that the rate of growth continues on the same curve, the predicted number of cells in the experiment is 1920.
  - 2 During the 80 minutes after the start of the experiment there was a 400% increase in the number of cells.
  - 3 The growth curve is of the form  $y = 30k^x$
- A** none of them
- B** 1 only
- C** 2 only
- D** 3 only
- E** 1 and 2 only
- F** 1 and 3 only
- G** 2 and 3 only
- H** 1, 2 and 3



- 54** Three samples of cells were taken from the same healthy human: one sample from the blood, one sample from a kidney, and one sample from a testis.

Each sample contained five cells, three of one type and two of a different type. None of the cells were dividing.

In each sample, the mean number of chromosomes per cell was calculated. The results are shown in the table.

<i>sample</i>	<i>mean number of chromosomes per cell</i>
1	18.4
2	32.2
3	46.0

Which row in the following table identifies the samples from the kidney and the testis?

(Assume that no mutations occur in any of the cells in the samples.)

	<i>kidney</i>	<i>testis</i>
<b>A</b>	1	2
<b>B</b>	1	3
<b>C</b>	2	1
<b>D</b>	2	3
<b>E</b>	3	1
<b>F</b>	3	2

- 55 The graph shows the mean mass of DNA of a population of cells dividing at the same time, measured in femtograms ( $10^{-15}$  g) per cell.

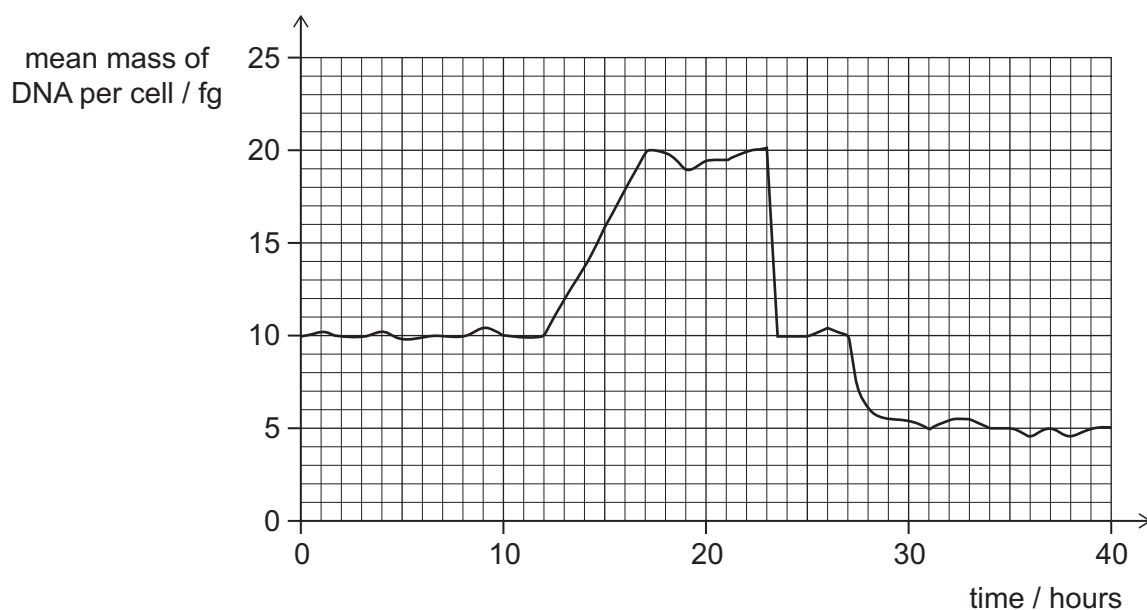

Which row in the table is correct?

	<i>type of cell division taking place</i>	<i>rate of DNA synthesis per cell between 12 and 17 hours / fg h<sup>-1</sup></i>	<i>period that could be part of interphase</i>
<b>A</b>	meiosis	2	0 to 17 hours
<b>B</b>	meiosis	0.5	0 to 17 hours
<b>C</b>	meiosis	2	12 to 24 hours
<b>D</b>	meiosis	0.5	12 to 24 hours
<b>E</b>	mitosis	2	0 to 17 hours
<b>F</b>	mitosis	0.5	0 to 17 hours
<b>G</b>	mitosis	2	12 to 24 hours
<b>H</b>	mitosis	0.5	12 to 24 hours

- 56** A plasmid contains genes Q and R. Gene Q codes for resistance to the antibiotic *q*. Gene R codes for resistance to antibiotic *r*.

The plasmid was genetically engineered to contain the human gene P. This gene was inserted into gene Q in the plasmid preventing gene Q from working.

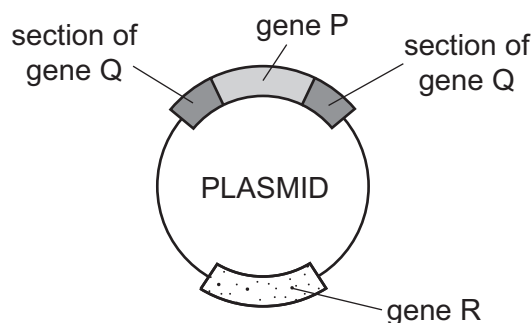

A mixture of the original plasmid and the genetically-engineered plasmid were available to be taken up by bacterial cells. The bacterial cells took up either the original plasmid, or the genetically-engineered plasmid, or neither of the plasmids.

All these bacteria were allowed to grow and form colonies on agar plates in the absence of both antibiotics.

40 colonies formed.

Cells from each of the 40 colonies were grown on three agar plates with different contents.

The table shows the number of colonies that grew on each of the three plates.

<i>contents of agar plate</i>	<i>number of bacterial colonies able to survive on the agar plate</i>
no antibiotic	40
antibiotic <i>q</i> only	8
antibiotic <i>r</i> only	24

What percentage of the original 40 bacteria now contain gene P?

(Assume that no mutations occur.)

- A** 16%
- B** 20%
- C** 33%
- D** 40%
- E** 60%
- F** 80%

- 57 One form of genetic variation within a population depends on the number of alleles per gene.

Four populations of the same animal species each have the same gene in the same position on a chromosome.

Each population has a different number of alleles for this gene as shown in the table.

<i>population</i>	<i>number of alleles for the same gene</i>
P	3
Q	4
R	5
S	6

Assume that in the heterozygous state, the genotype is the same whether an allele is inherited from the mother or the father.

Which of the following is/are correct for this gene?

(Assume that no mutations occur in this gene.)

- 1 The theoretical number of different genotypes in population S is 6 more than in population R.

2

<i>theoretical number of different homozygous genotypes in population</i>			
P	Q	R	S
3	4	5	6

- 3 In populations P, Q and R, there are more different homozygous combinations than there are different heterozygous combinations.

- A none of them  
 B 1 only  
 C 2 only  
 D 3 only  
 E 1 and 2 only  
 F 1 and 3 only  
 G 2 and 3 only  
 H 1, 2 and 3

- 58 The diagram shows a cylinder with two compartments, X and Y, separated by a sliding partially permeable membrane which is impermeable to glucose.

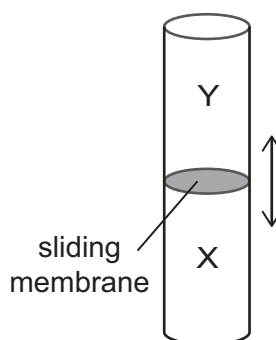

Compartment X contains  $100 \text{ mmol dm}^{-3}$  glucose solution and compartment Y contains  $200 \text{ mmol dm}^{-3}$  glucose solution. The initial volume of the solution in each of the two compartments is the same,  $10 \text{ cm}^3$ .

After three hours, there is no further change in the volumes of X and Y.

Which of the following statements describe(s) the results of the experiment?

- 1 The volume of Y increases during the first three hours.
  - 2 During the first three hours, the average rate of osmosis is  $\frac{10}{9} \text{ cm}^3$  per hour.
  - 3 During the first three hours, the average rate of change in glucose concentration in compartment X is  $50 \text{ mmol dm}^{-3}$  per hour.
- A 1 only
- B 2 only
- C 3 only
- D 1 and 2 only
- E 1 and 3 only
- F 2 and 3 only
- G 1, 2 and 3

- 59** A fertilised egg cell is spherical and has a volume of  $0.12 \mu\text{m}^3$ .

In the initial stages of development, the fertilised egg cell undergoes several rounds of cleavage. During cleavage, cells divide by mitosis but do not grow. Assume that when cells undergo cleavage, the daughter cells are spherical and are identical to each other.

Which of the following statements about the cells present after three rounds of cleavage is/are correct?

- 1** Each cell will contain  $\frac{1}{8}$  of the DNA present in the fertilised egg cell.
  - 2** The volume of each cell will be  $0.03 \mu\text{m}^3$ .
  - 3** The diameter of the cells is 50% of that of the fertilised egg cell.
- A** none of them
- B** 1 only
- C** 2 only
- D** 3 only
- E** 1 and 2 only
- F** 1 and 3 only
- G** 2 and 3 only
- H** 1, 2 and 3

- 60** The genetic code is read in groups of three bases when coding for the synthesis of a protein. The diagram shows the base triplets within DNA that correspond to specific amino acids.

The diagram is read from the inside out. For example, the base triplets CAT and CAC both code for the amino acid histidine (His).

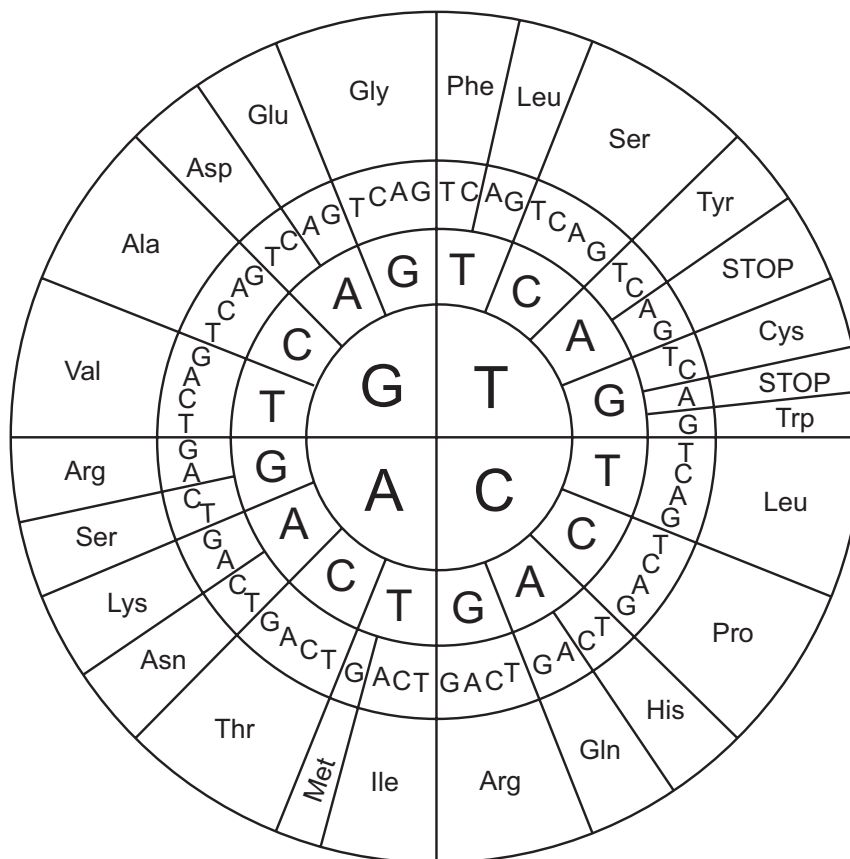

Assume that it is equally likely that mutations can change any base to any other base, and that the probability of this resulting in a change in any particular base during one cell division is  $2 \times 10^{-9}$ .

What is the probability that a triplet that codes for **Met** changes to code for **Pro** in one round of division?

- A**  $\frac{4}{9} \times 10^{-18}$
- B**  $\frac{4}{9} \times 10^{-9}$
- C**  $\frac{2}{3} \times 10^{-18}$
- D**  $\frac{2}{3} \times 10^{-9}$
- E**  $4 \times 10^{-18}$
- F**  $4 \times 10^{-9}$



**Cambridge Assessment**  
Admissions Testing